

View 1

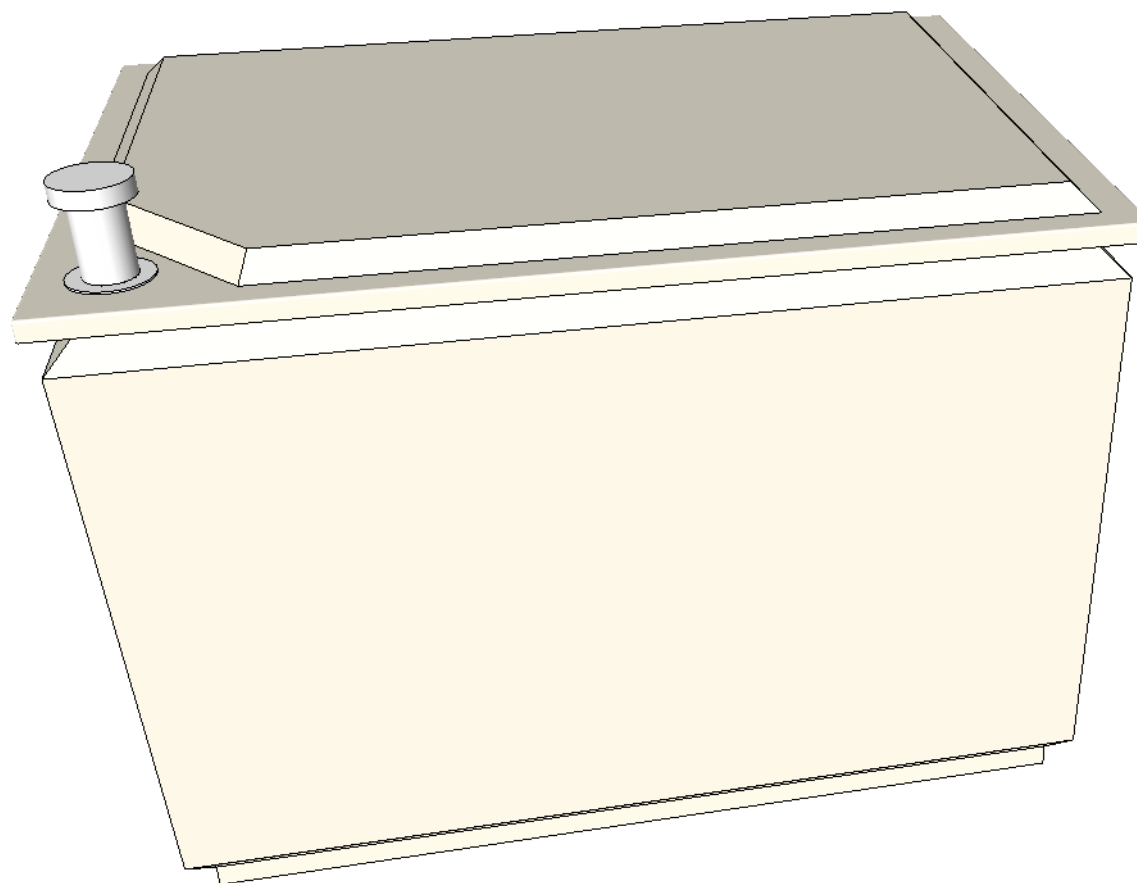

**Notes:**

- a) All dimensions are approximate and may change without notice. If dimensions are required for a specific purpose such as sizing framework these can be provided on request.
- b) Insulation 25mm PU foam encapsulated within a GRP outer skin. U-value 0.8 W/m<sup>2</sup>K
- c) Recesses for connections are factory formed (standard positions shown dotted).
- d) Holing of tank and fitting connections by others unless ordered.
- e) Tank sides may have a small draw angle for moulding purposes

**Model: ANP100/1**

**Capacity (nominal): 460 litre      100 gal**

**ISSUE**  
9/9/13

**DRAWN BY**  
SC

View 2

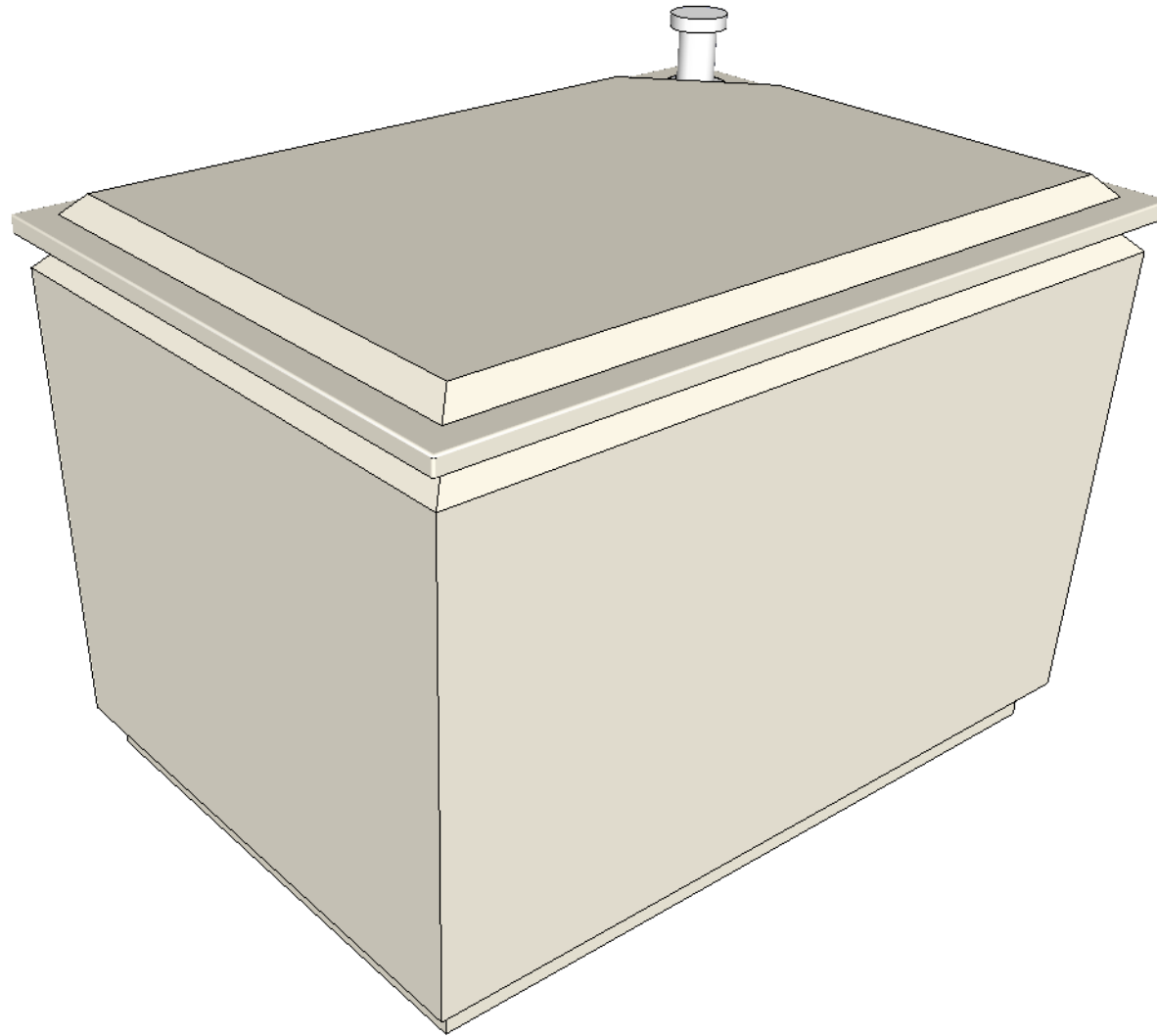

**Model: ANP100/1**

**Capacity (nominal): 460 litre      100 gal**

**ISSUE**  
9/9/13

**DRAWN BY**  
SC

Plan

1040 mm

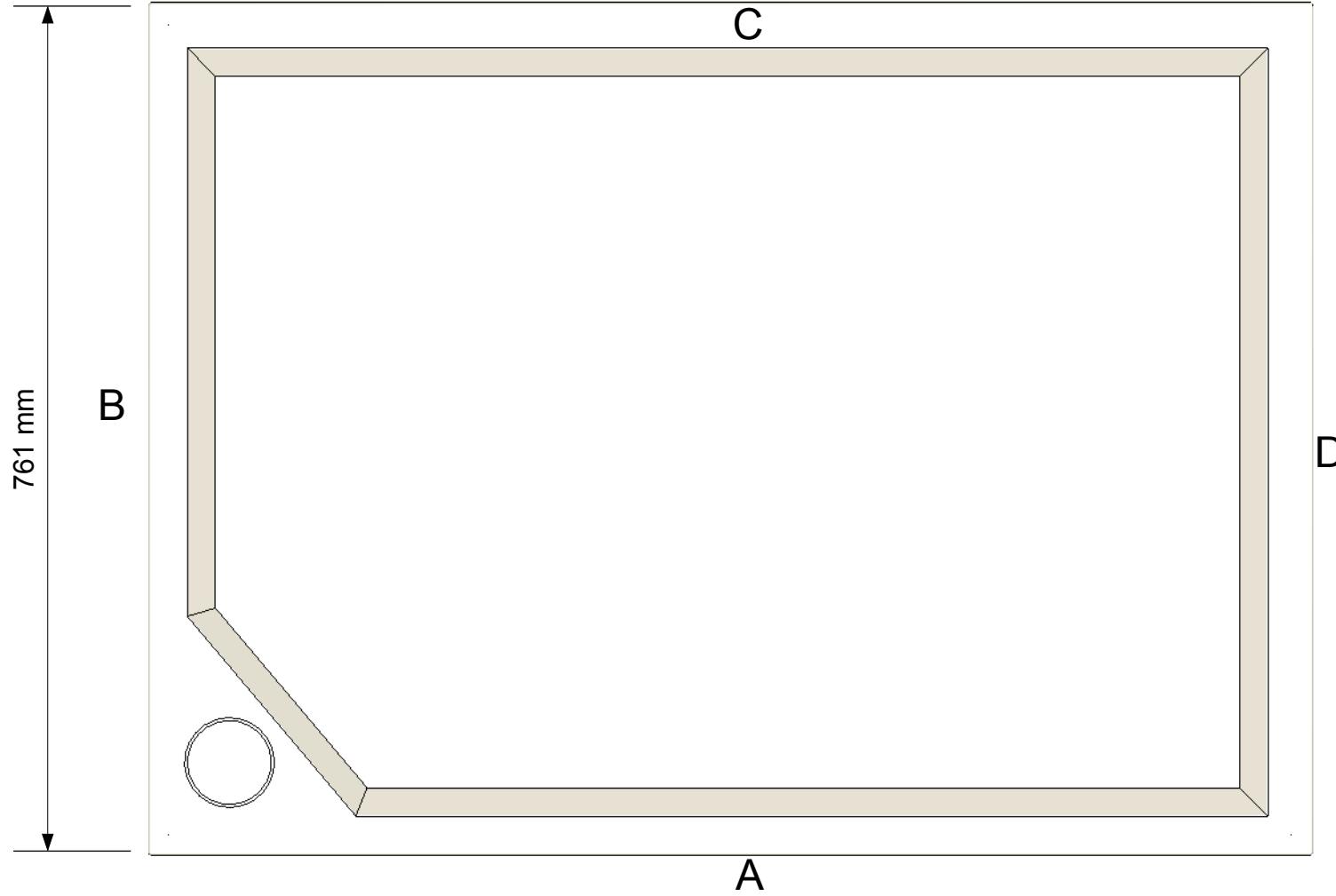

**Model: ANP100/1**

**Capacity (nominal): 460 litre    100 gal**

**ISSUE**  
9/9/13

**DRAWN BY**  
SC

# Elevation A

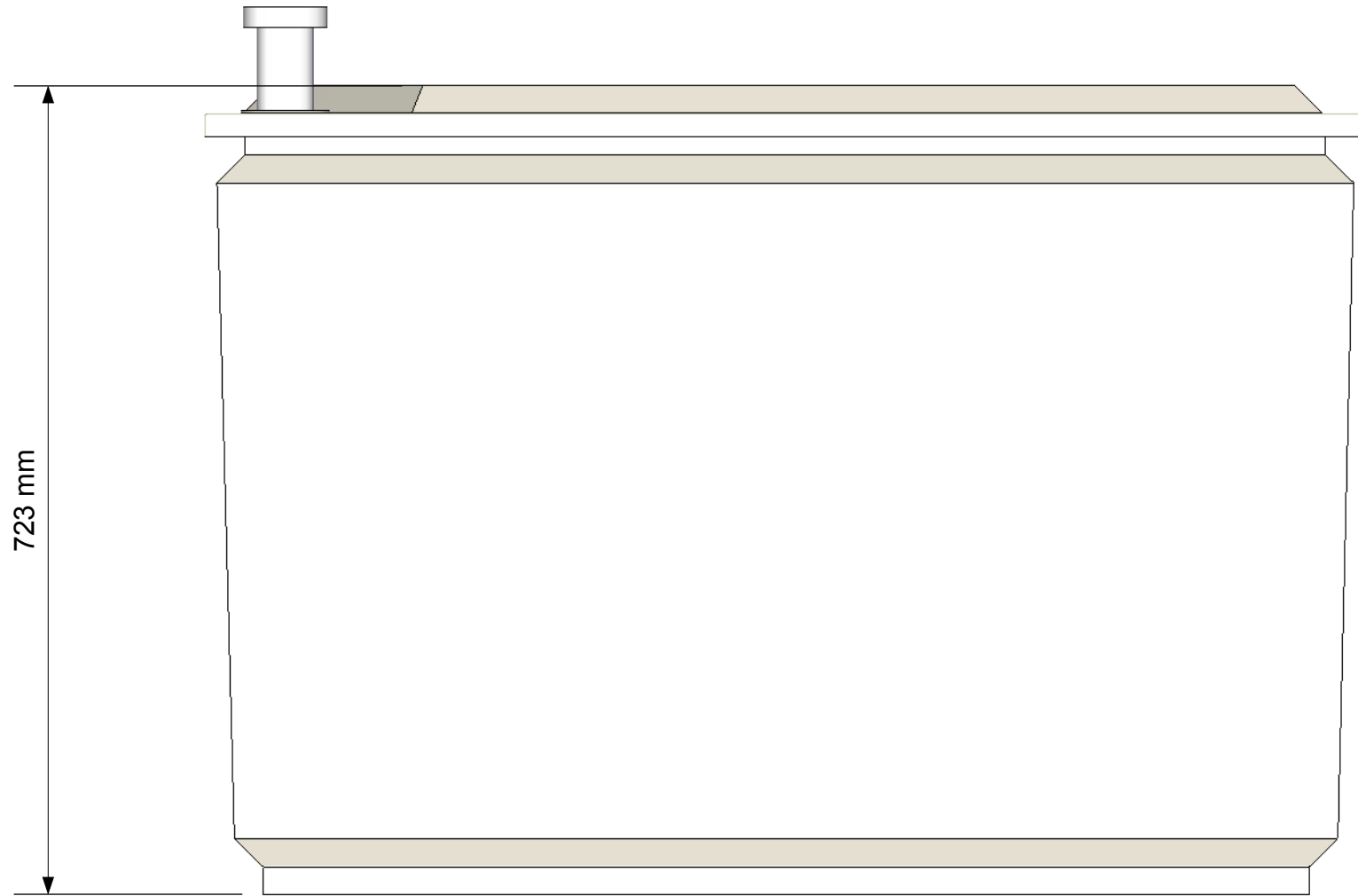

**Model: ANP100/1**

**Capacity (nominal): 460 litre    100 gal**

**ISSUE**  
9/9/13

**DRAWN BY**  
SC

# Elevation B

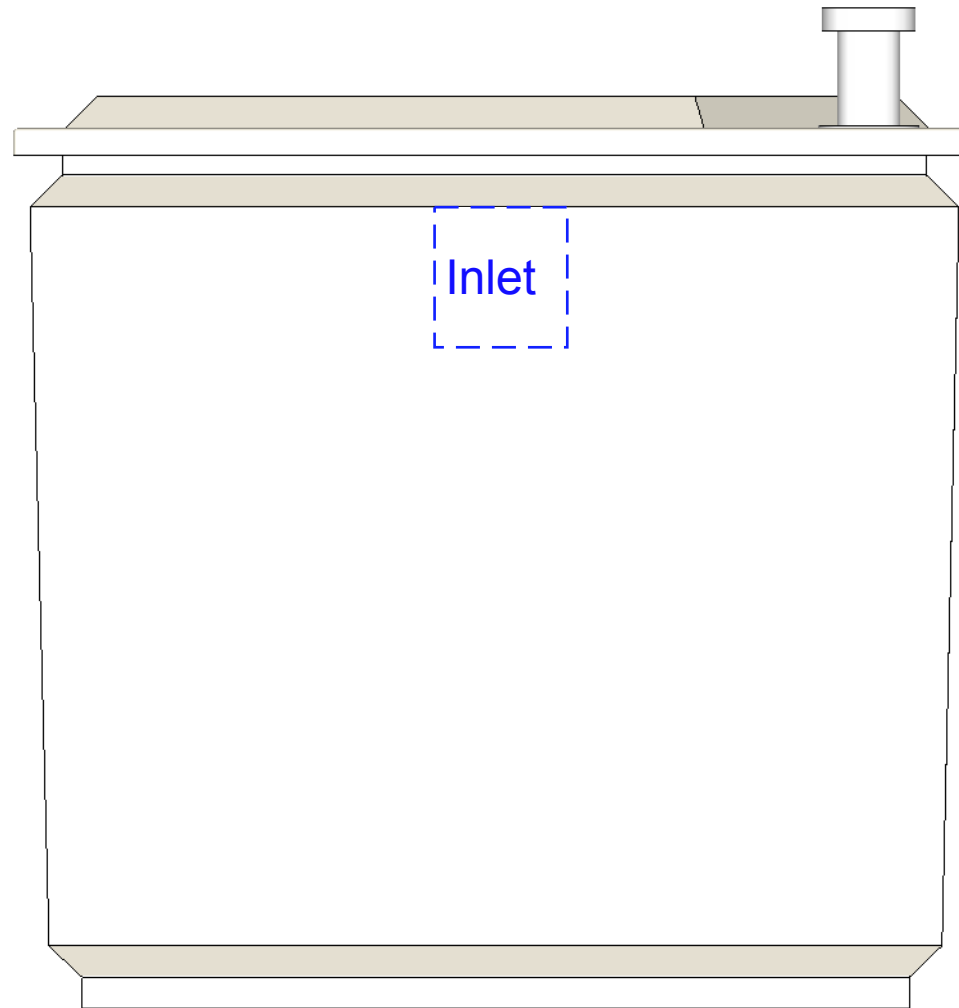

**Model: ANP100/1**

**Capacity (nominal): 460 litre      100 gal**

**ISSUE**  
9/9/13

**DRAWN BY**  
SC

# Elevation C

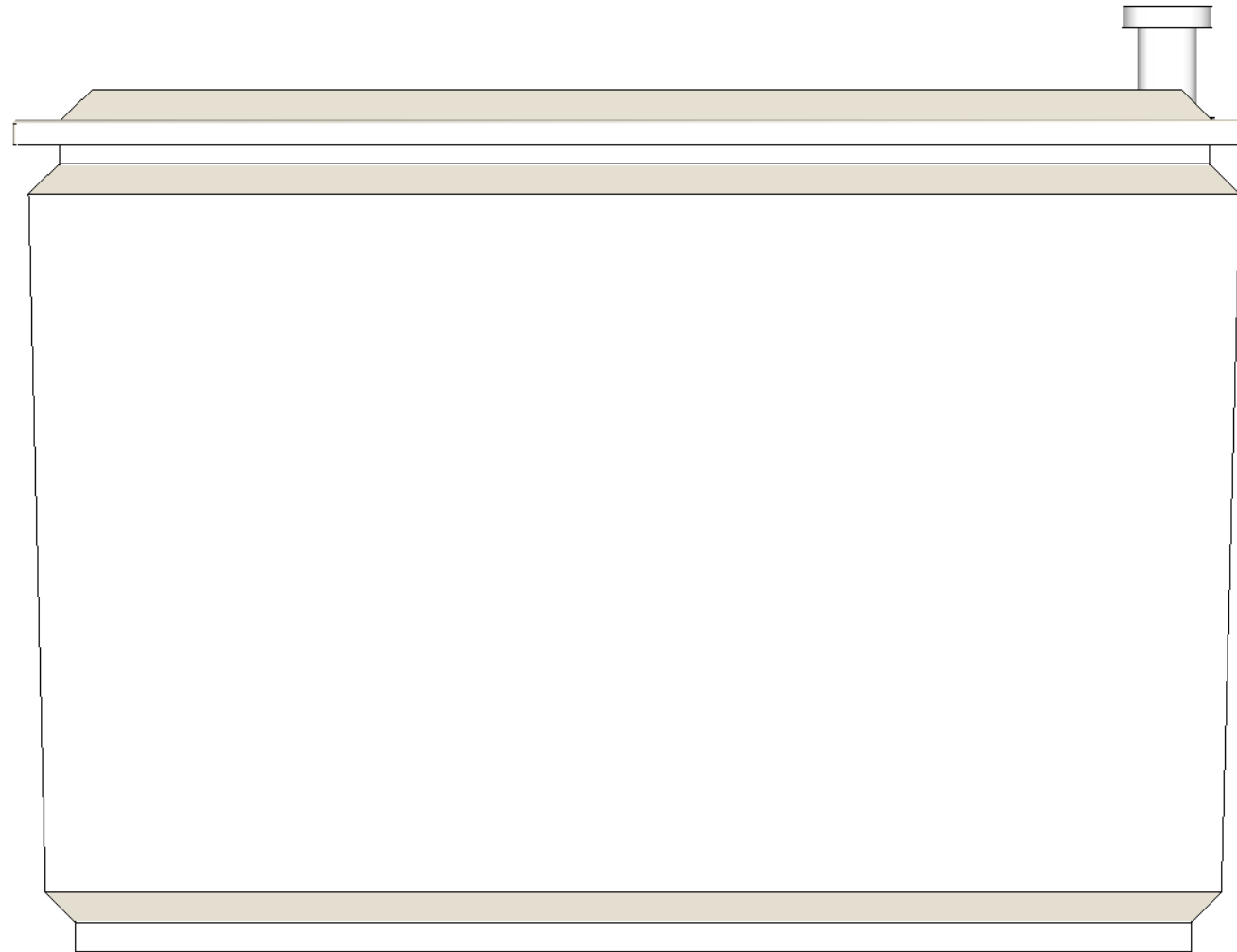

**Model: ANP100/1**

**Capacity (nominal): 460 litre      100 gal**

**ISSUE**  
9/9/13

**DRAWN BY**  
SC

# Elevation D

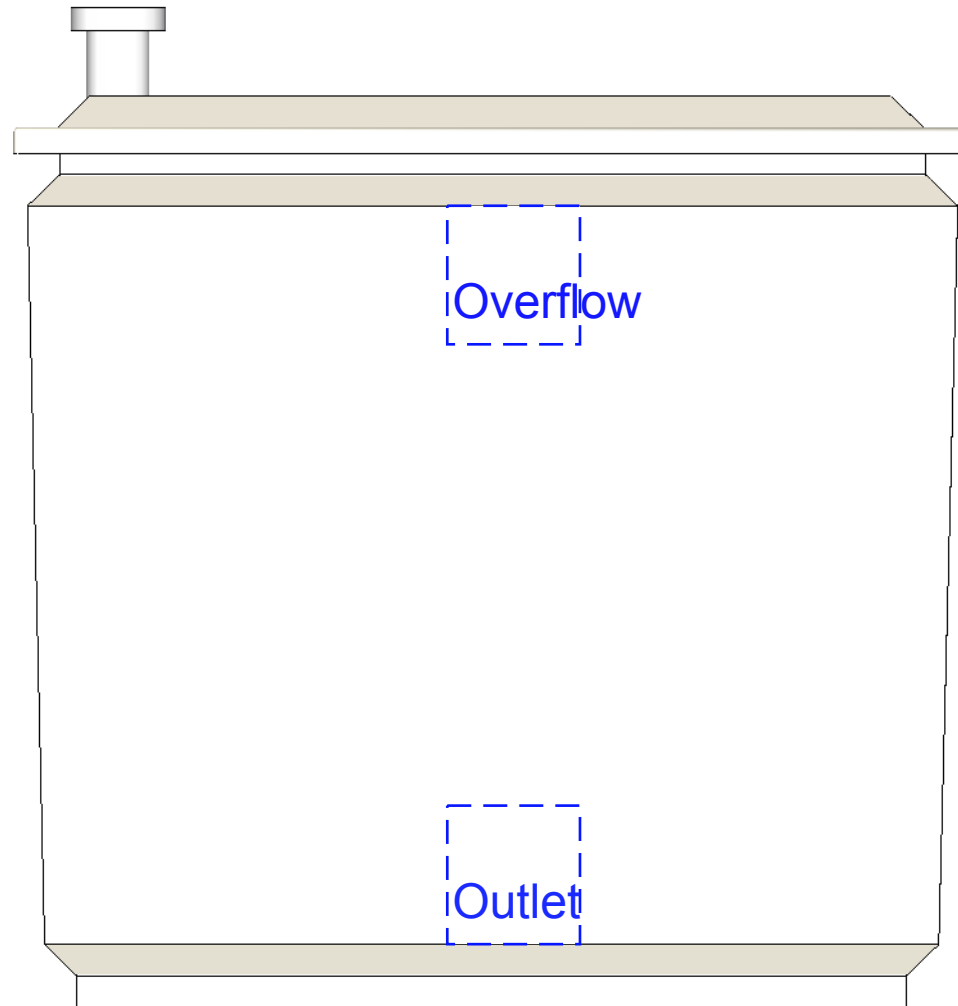

**Model: ANP100/1**

**Capacity (nominal): 460 litre      100 gal**

**ISSUE**  
9/9/13

**DRAWN BY**  
SC