

View 1

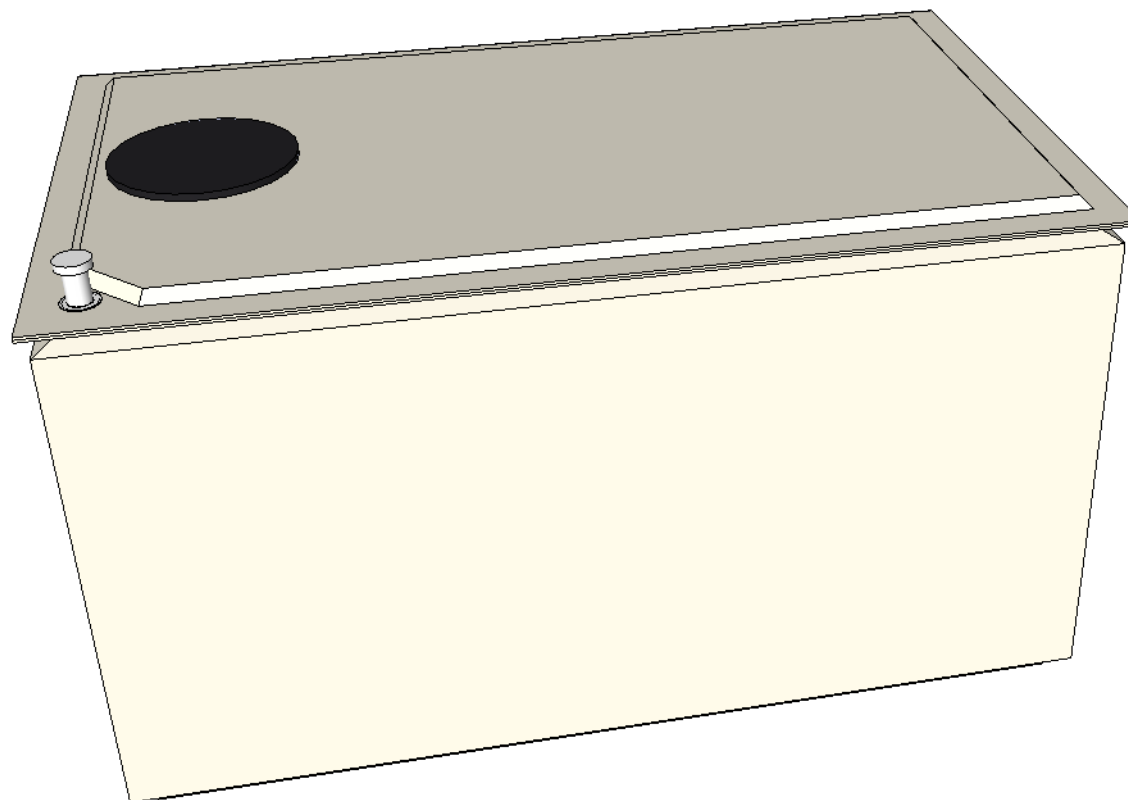

Notes:

- a) All dimensions are approximate and may change without notice. If dimensions are required for a specific purpose such as sizing framework these can be provided on request.
- b) Insulation 50mm PU foam encapsulated within a GRP outer skin. U-value 0.4 W/m2K
- c) Recesses for connections are factory formed (standard positions shown dotted).
- d) Holing of tank and fitting connections by others unless ordered.
- e) Tank sides may have a small draw angle for moulding purposes

Model: ANP700

Capacity (nominal): 3190 litre 700 gal

ISSUE
9/9/13

DRAWN BY
SC

View 2

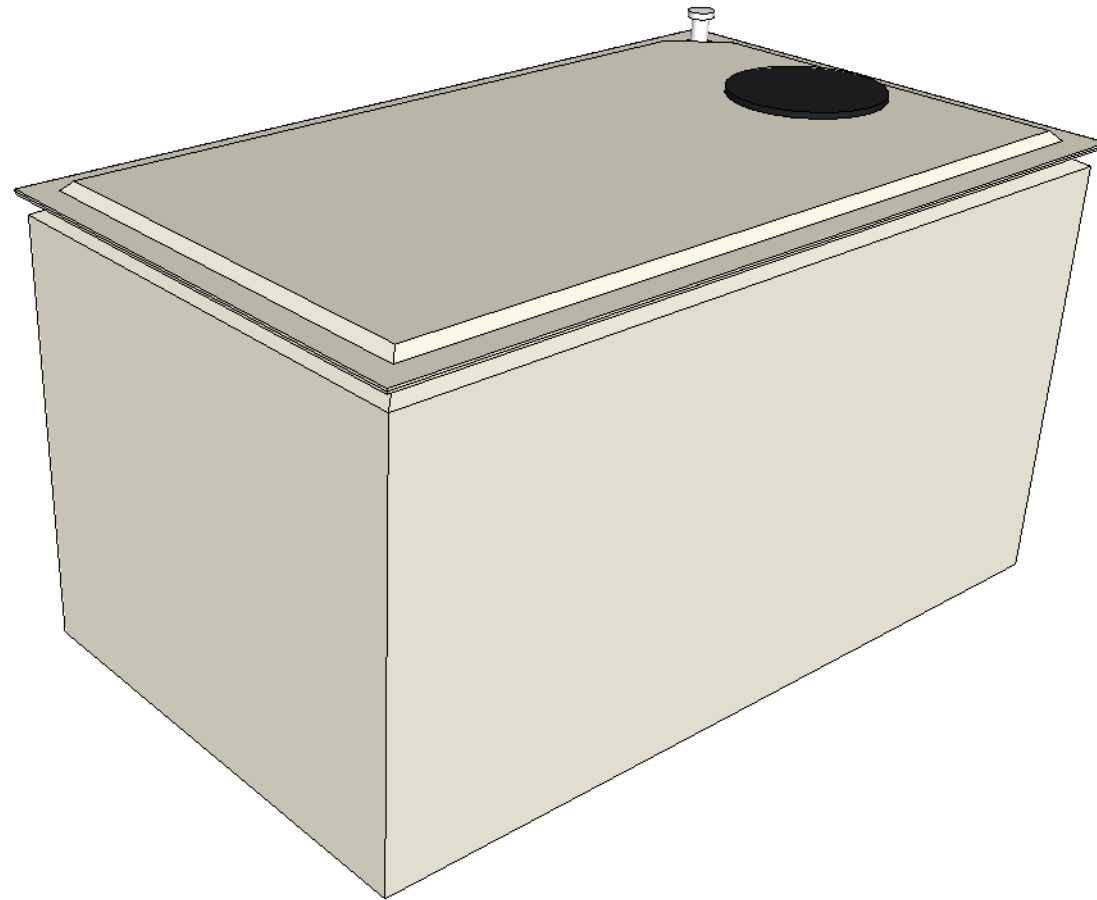

Model: ANP700

Capacity (nominal): 3190 litre 700 gal

ISSUE
9/9/13

DRAWN BY
SC

Plan

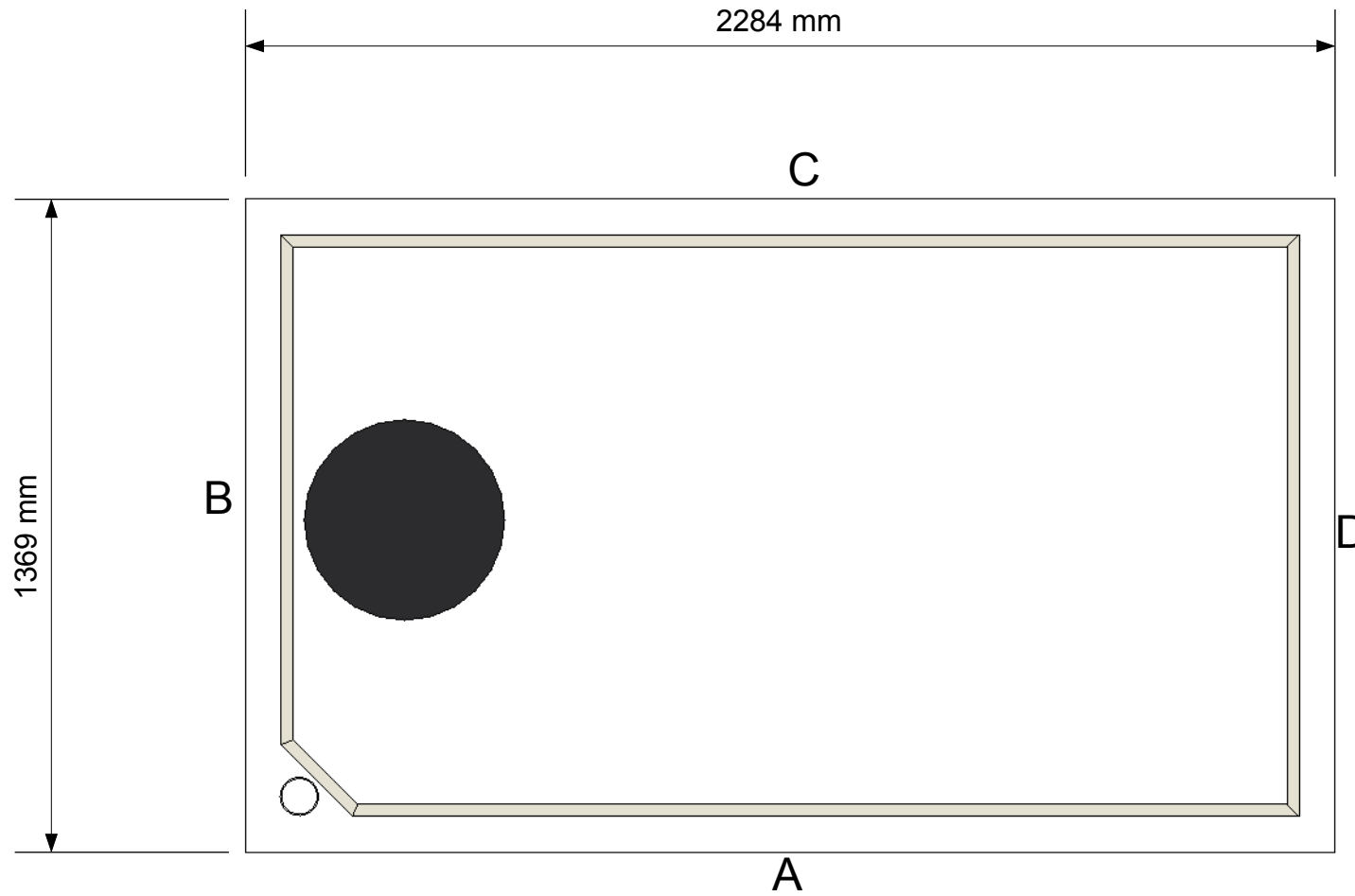

Model: ANP700

Capacity (nominal): 3190 litre 700 gal

ISSUE
9/9/13

DRAWN BY
SC

Elevation A

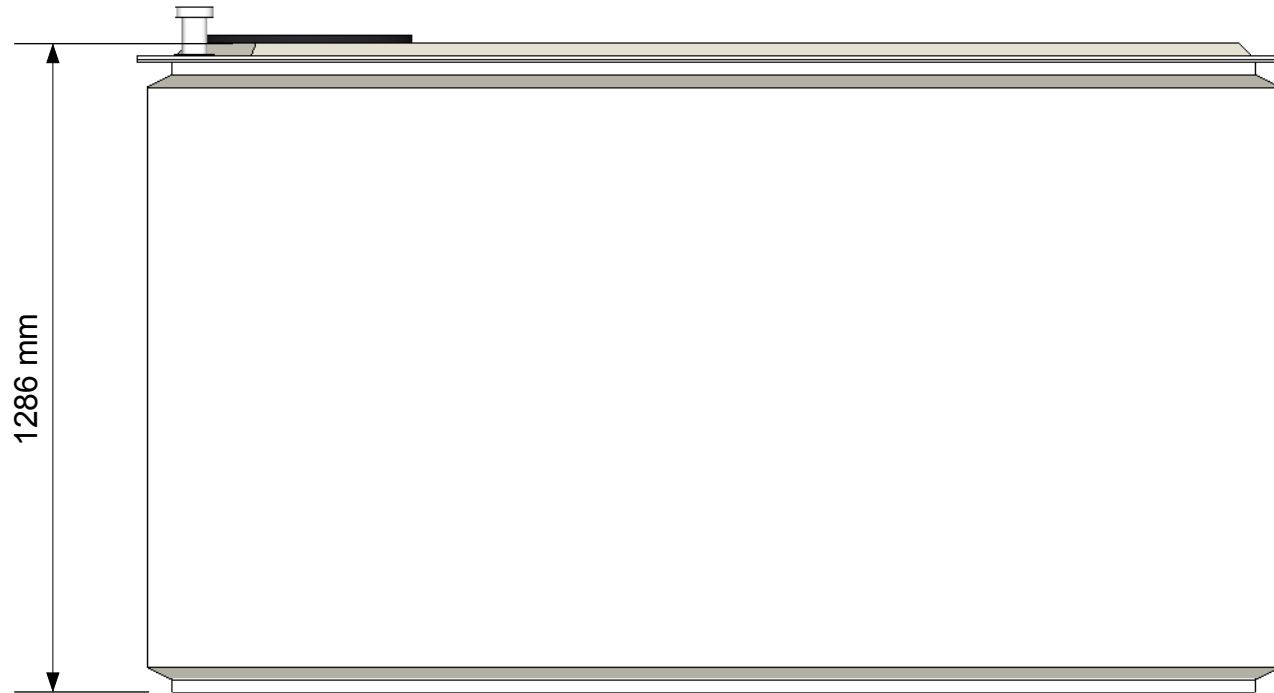

Model: ANP700

Capacity (nominal): 3190 litre 700 gal

ISSUE
9/9/13

DRAWN BY
SC

Elevation B

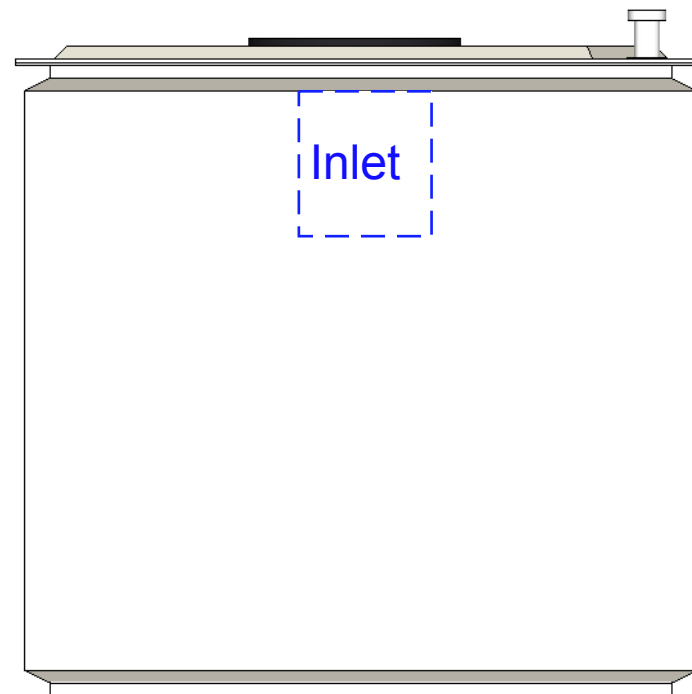

Model: ANP700

Capacity (nominal): 3190 litre 700 gal

ISSUE
9/9/13

DRAWN BY
SC

Elevation C



Model: ANP700

Capacity (nominal): 3190 litre 700 gal

ISSUE
9/9/13

DRAWN BY
SC

Elevation D

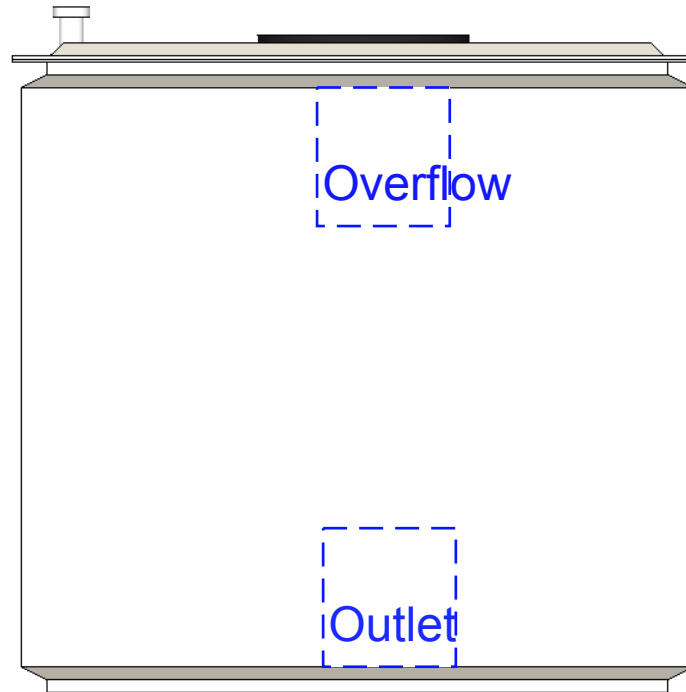

Model: ANP700

Capacity (nominal): 3190 litre 700 gal

ISSUE
9/9/13

DRAWN BY
SC